

The Challenge Machinery Company provides owner's manuals on its products solely as a courtesy to its customers. See the information below before using this manual.

These manuals are for reference only. These manuals include products which are noncurrent, unsupported or no longer produced by The Challenge Machinery Company, and are provided solely as an accommodation to our customers. By providing these manuals, The Challenge Machinery Company makes no representation or warranty as to the products, their current condition, or their suitability or fitness for use in any particular application, which are the sole and independent responsibility of the product owner and user.

**Older products may not comply with current safety procedures, guidelines or regulations, and it is the product owner's and user's responsibility to evaluate the suitability and fitness of the products in their current use and application. The Challenge Machinery Company makes no representation, warranty or recommendation regarding any modifications which may be required on non-current or unsupported products. The Challenge Machinery Company assumes no liability for any modification or alteration to any Challenge product, and any such modification or alteration to any Challenge product is not authorized by The Challenge Machinery Company.** The availability of these manuals is solely for the purpose of providing reference information for the products.

This manual may not be complete in all aspects of product maintenance and repair. **All products should be used only by qualified and properly trained personnel, following proper safety procedures.** All products should be regularly inspected and maintained, and their condition, application and use should be periodically evaluated by qualified personnel. Only qualified and properly trained technicians should perform maintenance, repair and replacement procedures. Attempting these procedures without proper training may cause machine damage or operator injury!

Products may be unsupported by The Challenge Machinery Company due to age or the unavailability of parts from their original manufacturer. No parts or product support will be available to repair or maintain unsupported products. Older products may not be UL listed (if the product does not have a UL label it is not a listed product), and may not comply with applicable installation or other regulations or requirements if relocated to a new facility. Many municipalities require a product to be UL listed before an electrician will connect power to them. Often the cost of updating an older product to comply with current safety regulations is greater than the value of the product.



**The Challenge Machinery Company**  
6125 Norton Center Drive  
Norton Shores, MI 49441-6081 USA

ChallengeMachinery.com

## ***MODEL MS-10B***

### ***Operator's Manual***

**Serial Numbers:**  
**095305 through 159999,**  
**MS10-B-159999 and up**

*Sold and Serviced by*

**F.399-DO**

Jan 2024

# 1.0 Introduction

THIS MANUAL is designed to help you get the most from your Challenge equipment. Keep this manual in a safe, convenient place for quick reference by operators and service personnel.



**SAFETY ALERT!** This symbol means **CAUTION: Personal safety instructions!** Pay special attention to the instructions in bold type. Personal injury may result if the precautions are not read and followed.

**READ THIS MANUAL BEFORE OPERATING!** Follow precautions and instructions given and you should have years of trouble-free operation. If after reading the manual questions still remain, contact your Authorized Challenge Dealer.

**FOR PARTS AND SERVICE,** contact the Authorized Challenge Dealer from whom you purchased your machine. Use the illustrations and parts lists at the back of this manual to identify the correct parts needed. Always give the **SERIAL NUMBER** and **MODEL** of your machine to insure the correct parts are sent as soon as possible.

Take a few minutes right now to **RECORD YOUR MACHINE SERIAL NUMBER** in the space provided below. Also be sure to fill out the warranty card accompanying your machine and return it **DIRECTLY TO CHALLENGE.**

If you bought a used machine, it is important to have the following information on record at Challenge. Copy this page, fill in the information and send it care of The Challenge Service Department, 6125 Norton Center Drive • Norton Shores • MI 49441-6081.

CHALLENGE MODEL	SERIAL NUMBER	
ATTN	COMPANY	
ADDRESS		
CITY	STATE/PROVINCE	ZIP
PHONE	DATE INSTALLED	
DEALER NAME & CITY		

**\* WARRANTY INFORMATION \***

It is very important that you read and understand the conditions outlined in the *Warranty Information Sheet* attached to the outside of the shipping container of your machine.

The *Warranty Information Sheet* must be filled out completely and returned to THE CHALLENGE MACHINERY COMPANY in order for the warranty to be issued for this machine.

Challenge® is a registered trademark of  
 The Challenge Machinery Company • 6125 Norton Center Drive • Norton Shores, MI 49441-6081  
 Copyright© 1999-2024 by The Challenge Machinery Company. All rights reserved. Printed in the U.S.A

## TABLE OF CONTENTS

1.0 Introduction .....	2
2.0 Safety .....	4
2.1 Precautions .....	4
2.2 Power Lockout Procedure .....	4
2.3 Warning Label Definitions .....	5
3.0 Specifications .....	6
4.0 Packing List .....	7
5.0 Options .....	8
5.1 Drill Head Configurations .....	9
6.0 Installation Guide .....	11
6.1 Uncrating the Paper Drill .....	11
6.2 Power Hook Up .....	11
6.2.1 Three Phase Hook-Up .....	12
6.3 Controls .....	13
6.4 Vertical Speed .....	13
6.5 Assembly .....	13
6.5.1 Drill Blocks .....	14
6.5.2 Mounting Drill Heads .....	14
6.5.3 Mounting the Side Guide .....	16
6.5.4 Installing/Removing the Hollow Drills .....	17
7.0 Operation .....	18
7.1 STARTING THE MACHINE .....	18
7.2 OPERATING THE DRILL .....	18
7.3 ADJUSTING THE VERTICAL STROKE .....	18
7.4 POSITIONING THE DRILL HEADS .....	19
7.5 POSITIONING THE BACKGAUGE .....	19
7.6 EMPTYING THE DRILL CHIP BIN .....	19
7.7 TOOL STORAGE .....	19
7.8 DRILLING TIPS .....	19
7.9 Routine Maintenance .....	21
8.0 Accessories .....	22
8.1 Genuine Challenge Hollow Drills .....	22
8.2 Drill Ease .....	22
8.3 Challenge Drilling Blocks .....	22
8.4 Hollow Drill Hand Sharpener .....	23
8.5 Handy - Sharp - Hollow Drill Sharpener .....	24
8.6 Two Hand Push Button Control .....	25
8.7 Extension Side Tables .....	25
8.8 Wheeled Dolly .....	25
8.9 Cornermatic Round Cornering Attachment .....	25
8.10 Fiber Cutting Blocks .....	26
8.11 Plastic Drilling Blocks .....	26
8.12 Automatic Trip Side Guide .....	26
8.13 Extra Side Guide Stops .....	26
8.14 Fixed Side Guide .....	26
8.15 Fixed Side Guide Gages .....	26
8.16 Chip Chute Extension .....	26
8.17 Drill Head Grease .....	26
8.18 Rykon 100 Hydraulic Oil .....	27
8.19 Large Hole Hollow Drill bits .....	27

## 2.0 Safety

---

### 2.1 Precautions

- This machine is designed for one-person operation. Never operate the machine with more than one person.
- Safe use of this machine is the responsibility of the operator. Use good judgment and common sense when working with and around this machine.
- Read and understand all instructions thoroughly before using the machine. If questions remain, contact the dealer from which you purchased this machine. Failure to understand the operating instructions may result in personal injury.
- Only trained and authorized people should operate this machine.
- Do not alter safety guards or devices. They are for your protection. Severe personal injury may result.
- Disconnect power before cleaning or performing maintenance. See Section 2.2 Power Lockout Procedure.
- Observe all caution labels on this machine.
- High Speed Drill - Keep rags, loose clothing and long hair away from rotating drill. Personal injury could result from items being caught on drill.
- Keep foreign objects off table and away from drill.
- Be extremely careful when handling and changing the drills. Severe lacerations or dismemberment could result from careless handling procedure.
- Keep the floor around the machine free of trim, debris, oil and grease.
- If the machine sounds or operates abnormally, turn it off and have it checked by a qualified service person or your Authorized Challenge Dealer.
- CRUSH HAZARD, keep feet off the pedal when handling paper under the pressure feet. DO NOT REST FOOT ON PEDAL at any time!
- DO NOT REACH UNDER THE DRILL AREA!
- DO NOT OPERATE WITH ANY GUARDS REMOVED! Replace all guards after adjusting, lubricating or servicing the machine.
- Severe Lacerations - Contact with high-speed drill could cause severe injury. Always turn machine off and wait for drill to stop before removing drill bits. Keep hands away from drill(s) when operating.

### 2.2 Power Lockout Procedure

For maximum safety when making adjustments or repairs to your machine, be sure to lock out the main power control switch to which the machine is connected. The switch should be moved to the OFF position and a padlock placed in the loop. The person servicing the machine should hold the key.

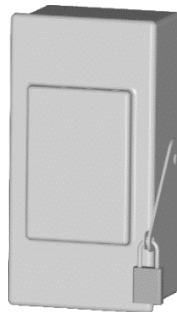

Figure 1

## 2.3 Warning Label Definitions

The following warning labels are found at various locations on your machine. Read and understand the meaning of each symbol. If a label is lost from the machine, it should be replaced. The item number and location of each label can be found in Section 17.0, Schematics and Parts List.



### HAZARDOUS AREA

Disconnect power before cleaning, servicing, or making adjustments not requiring power. Do not alter safety guards or devices; they are for your protection. Replace all guards. Do not operate with any guards removed.

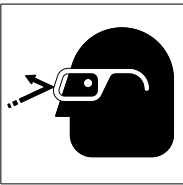

### EYE WEAR

Always wear eye protection when operating this machine.



### SHOCK HAZARD

Disconnect power before removing cover. Replace cover before operation.



### SINGLE OPERATOR

Do not operate with more than one person.

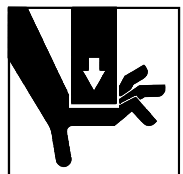

### CUT/CRUSH HAZARD

Keep hands from under drills.

# 3.0 Specifications

Description	Inch Units	Metric Units
Maximum number of drill heads	10	10
Drill Diameters *	13 sizes from 1/8" to 1/2"	3-13 mm
Lift Capacity	2" for drills 1/8-1/2" 2-1/2" for drills 1/4, 5/16, 3/8, 1/2	3-13 mm 6-13 mm
Center-to-Center Minimum	1-1/4"	3.2 cm
Center-to-Center Maximum	21"	53 cm
Minimum Distance Btw. Holes (with optional auto-trip side guide)		
w/adjustable stops	3/8"	9.5 mm
w/fixed gages	1/4"	6.4 mm
Maximum Drilling Capacity	2-1/2"	6.4 cm
Cycles per minute (adj)	18-26	18-26
Backgauge Adjustment	0-9"	0-23 cm
Vertical Adj. Of Individual Heads	1/4"	6 mm
<b>Dimensions</b>		
Table Space	18" x 27"	46 x 69 cm
Table Height	38"	96 cm
Overall Height	60"	152 cm
Overall Length	35"	89 cm
Overall Width	40"	102 cm
Floor Space Needed	9.7 sq. ft.	.90 sq. m.
Net Weight (approx.)	1350 lbs.	612 kg.
Shipping Weight	1660 lbs.	753 kg.
<b>Electrical</b>		
<b>Standard:</b> 3 Phase, 60 Hz, AC, Pump - 3/4H.P., Spindle - 3 H.P. Available in 208 Volts/14 Amps. 230 Volts/13.8 Amps. (Service size 20 Amps.)		
<b>Optional:</b> 3 Phase, 50 Hz, AC, Pump – 3/4 H.P., Spindle 3 H.P. Available in 208 Volts/14 Amps. Or 230 Volts/13.8 Amps. (Service size 20 Amps.)		
The MS10B <i>must</i> be wired to an individual line through a disconnect box with the proper voltage at the machine.		

\* See Options for Large Hole Drilling and Triple Drill Head for drilling 3 holes on 1" Centers

Challenge reserves the right to make changes to any product or specification without notice and without incurring responsibility to existing units.

## 4.0 Packing List

Part No.	Description	Qty.
	Basic Machine	1
A-4950-2	Hand Drill Sharpener / Chip Remover	1
A-6626	Wood Drill Blocks	12
A-6588	T- Handle Drill Drift	1
S-1718	Grease Gun	1
4688	Lubrication Stick	1
5064	Drilling Block Hook	1
6563-2	Filler Block	2
H-6955-506	Thumb Screws for Filler Blocks	2
6614	1 Pint Drill Head Grease	1
6629	1 Pint Gib Slide Lubricant	1
W-105	1/4" Hex Wrench	1
W-130	3/16" Hex Wrench	1
W-132	3/8" Hex Wrench	1
W-137	5/32" Hex Wrench	1
W-164	5/16" Hex 'T' Wrench	1

# 5.0 Options

---

Standard Drilling Head – P/N A-6594-6  
Capacity is 2-1/2"/6.4cm. One 1/4" & one 5/16"  
hollow drill included with each head.  
(Can also be used with 2" hollow drills)

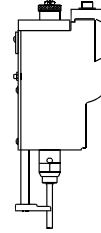

Triple Drilling Head – P/N A3-6594-5  
Drills three holes at once on 1" Centers.  
Capacity is 2-1/2"/6.4cm. Three 1/4" & three 5/16"  
X 2-1/2" hollow drills are included.

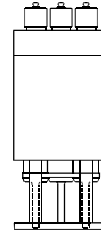

Large Hole Drilling Conversion Kit P/N A-6500-7 sh't 5  
This kit allows the drilling of hole diameters from  
9/16" to 1-1/2". Includes one large hole drill head,  
front guard cover extension, front and rear table adapter,  
and six plastic drill blocks. (Drill bits are not included.  
See Drill Accessories Section).

Large Hole Drill Head – A-6594-7  
Allows the drilling of 9/16" – 1-1/2" diameter holes.  
\*Requires the installation of Large Hole Drilling Conversion  
Kit. P/N A-6500-5



## 5.1 Drill Head Configurations

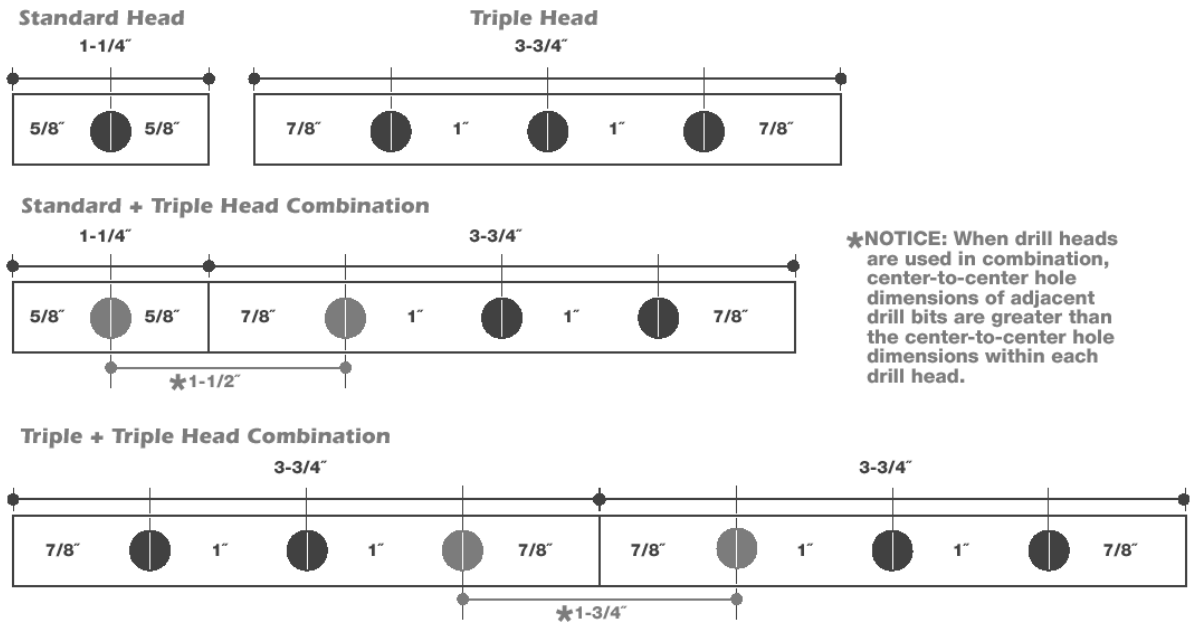

5.0 Options

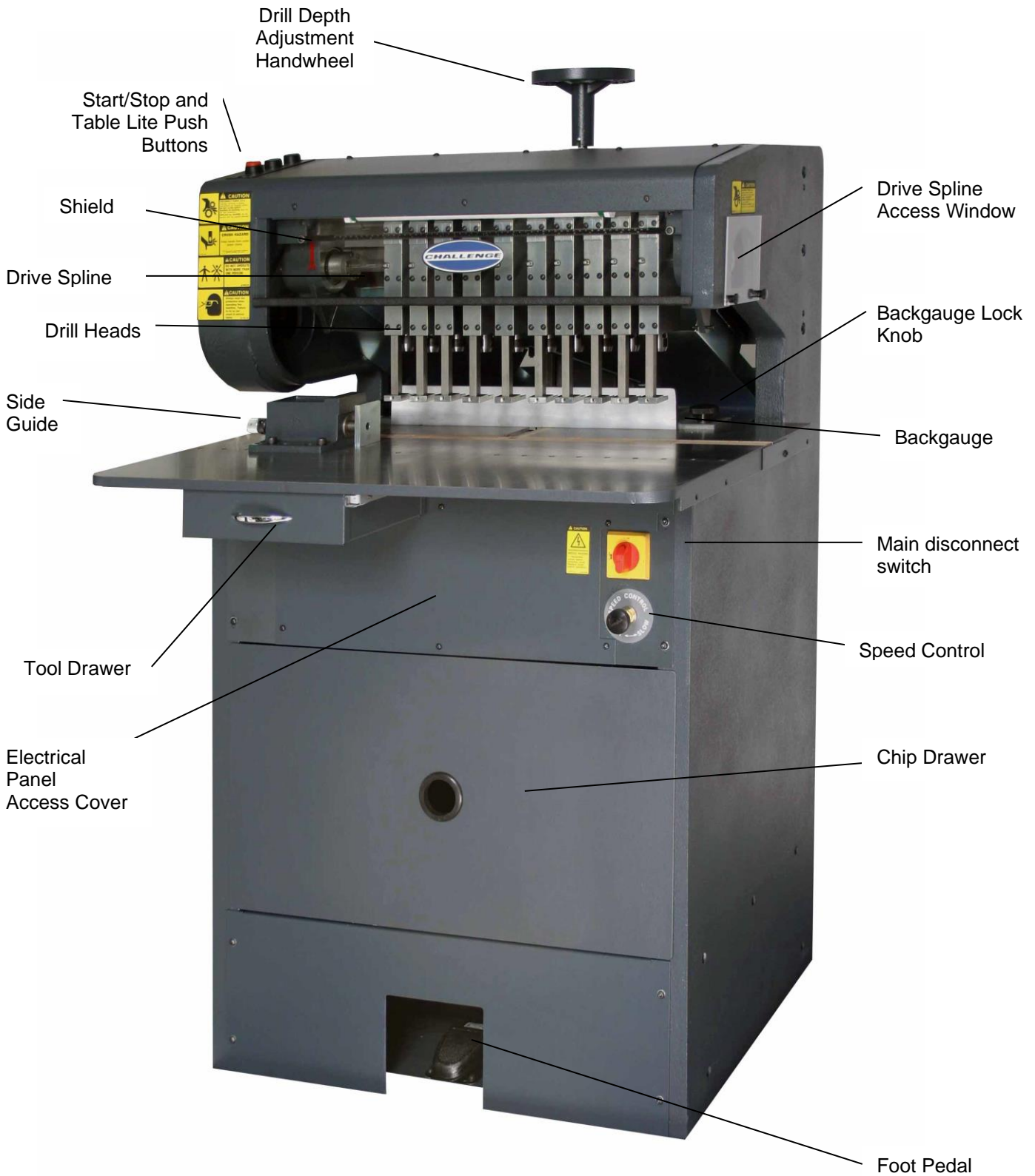

**MS-10B DRILL**

## 6.0 Installation Guide

---

Refer to the parts lists and drawings in the technical manual for part identification and orientation, as necessary.

All guards and instruction plates are installed for your safety and information and must remain on the machine as shipped from the factory.

### 6.1 Uncrating the Paper Drill

Unless otherwise specified, this machine is shipped in a wooden crate completely assembled. The machine should be unpacked by carefully removing the wood so as not to damage any of the machine parts. It is held onto the skid with lag bolts through the inside of machine frame. Remove the lag bolts and carefully position the machine on the floor. The machine can be safely be picked up by sliding the forks of a fork lift under the base of the machine or by removing the chip drawer and sliding the forks under the chip drawer slide brackets (take care not to hit or damage the hydraulic unit in the rear of the machine). Immediately after uncrating, check off parts received against the packing list. Also, examine for any physical signs of damage incurred during shipping. The machine is inspected before and after it is crated at our plant. The responsibility for filing a claim against the carrier for damages incurred during shipment rests with the receiver of goods (FOB our factory).

Clean all parts with a commercial cleaning solvent before installing or using the machine.

### 6.2 Power Hook Up

#### **CAUTION**

Always disconnect the power when cleaning, servicing, or lubricating your drill, see Power Lockout Procedure page 4.

For satisfactory operation, be sure that your machine is wired for the correct phase and voltage and has adequate power. The correct electrical specifications for your machine are shown on the serial plate. Check the machine serial plate before connecting the power. There is a junction box located on the left side of the machine with wires for power and a ground lug. After connecting power, briefly start and stop the machine and check motors for proper rotation. If incorrect, disconnect the power and switch any two leads coming to the machine.

**Watch Setup Voltage-** Inadequate power to the machine can be a major source of problems. Too many machines on the same circuit will reduce the power to each machine. Inadequate voltage will frequently cause overheating, loss of power, and in extreme cases, failure to operate. Test your voltage when the shop is at actual working levels. Challenge recommends a dedicated line with a lockable disconnect to provide adequate power for this machine.

#### **CAUTION**

**SHOCK HAZARD!** Always disconnect power at main power panel before working on the machine. Lock it out to prevent accidental power up. (See Power Lockout Procedure page 4).

**Important:** You must have an adequate size circuit and heavy enough wiring for this machine. The circuit size should be a minimum of 20% greater than the amperage rating on the machine nameplate. If a wire is run over 75 feet (23 meters), the next size wire should be used. Check local electrical codes.

### 6.2.1 Three Phase Hook-Up

1. Disconnect the power at the main power panel and lock it out to prevent accidental power-up. See Power Lock-Out procedure, page 4.
2. Thread the power cord through the knock-out hole in the junction box located on the left hand side of the machine. Secure it with a conduit connector.
3. Fasten the ground lead to the ground terminal lug found in the junction box.
4. Use wire nuts to join the three power leads to the L1, L2 and L3 leads found in the junction box.
5. Close all doors and guards, unlock the main power and switch it on. Turn on the Main Power Disconnect Switch located under the table on the front of the machine. The machine should now have power.
6. Depress the start button to activate the motors and check to make sure that they are turning the same direction as the arrow on the motor casing. If they are not, disconnect the power and simply exchange any two leads of the power cord as soon below. The motor will now turn the correct direction. Double check to make sure.

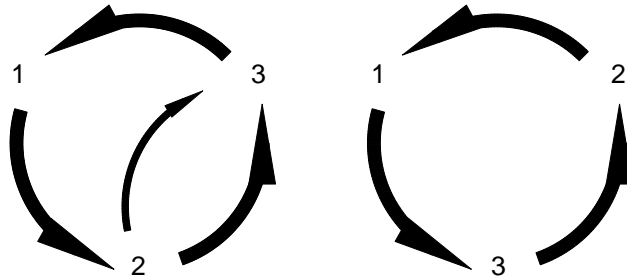

#### Electrical Specifications for MS10B DRILL:

	<u>Volts</u>	<u>Amps</u>	<u>Circuit Size</u>	<u>Wire Size</u>	<u>Metric Wire</u>
3 Phase:	230	13.8	20	#12	4mm sq.
	208	14	20	#12	4mm sq.

Standard electrical for the MS-10B is either 208/ 230 3 phase, 60 Hz. (Unless specified other.) It is the customer's responsibility to wire the machine for the rated voltage and current.

**IMPORTANT: Select the proper transformer primary tap to match the voltage supplied to the machine.**

## 6.3 Controls

The control panel is mounted on the top left of the machine.

The blue TABLE LIGHT push button turns the table light on and off.

The green START push button turns the spindle and pump motors on.

The red STOP push button will shut both motors off.

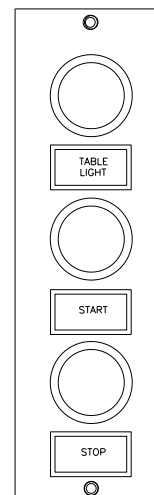

The MS-10B drill is equipped with a safety interlock system that prevents the machine from being run with the chip drawer removed or the spindle guard up. Also, if the cover is raised or the drawer opened while the machine is running, the motors will shut off and the machine will have to be restarted when the drawer and/or cover are back in place. This is a safety feature provided to prevent accidental contact with moving parts and must not be tampered with.

## 6.4 Vertical Speed

The vertical speed of the drilling head is adjusted with a control knob on the front of the machine under the table. This valve regulates the speed of the drill's downward travel. Light or soft stocks such as mimeographs, etc. are apt to wrinkle at high speeds, and the speed should therefore, be regulated to a point where the best results are obtained. This is found mostly be "trial and error"

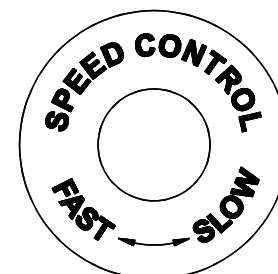

Also, too slow speeds will cause the drill to "burn" through the paper. If burning or burnishing occurs, either increase the vertical speed and/or sharpen the drill bits. Slower vertical speeds are recommended when drilling with the maximum number of heads.

## 6.5 Assembly



Always disconnect the power when cleaning, servicing, or lubricating your drill, see Lock Out Procedures, page 4.

The only assembly required is to insert the drill blocks and side guide onto the table and mount the drill heads in the machine.

### 6.5.1 Drill Blocks

The wood blocks are inserted in the table slot as shown in Figure 3. The blocks should be flush with the table top, shim if necessary. The blocks can be turned around and over when worn.

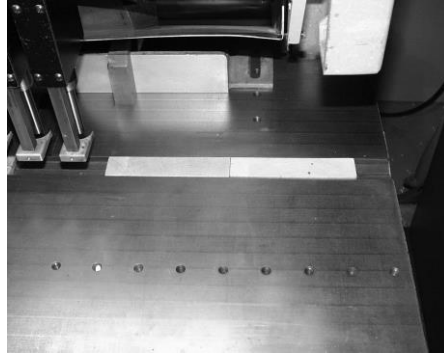
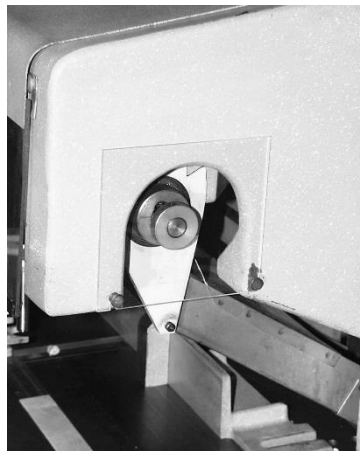

**Figure 3**

### 6.5.2 Mounting Drill Heads

The drill heads are inserted as follows:

1. Locate the plastic cover on the right hand side of the machine. Loosen the front knob and rotate cover back to expose lock knob. (See Figure 4)



**Figure 4**

**WARNING: DO NOT** use this machine without having the guard shown in fig. 4 is in place.

2. Rotate the spindle lock knob until the cut out in the knob aligns with the pin in the spline shaft and pull the shaft out. (See Figure 5 & Figure 6, below)

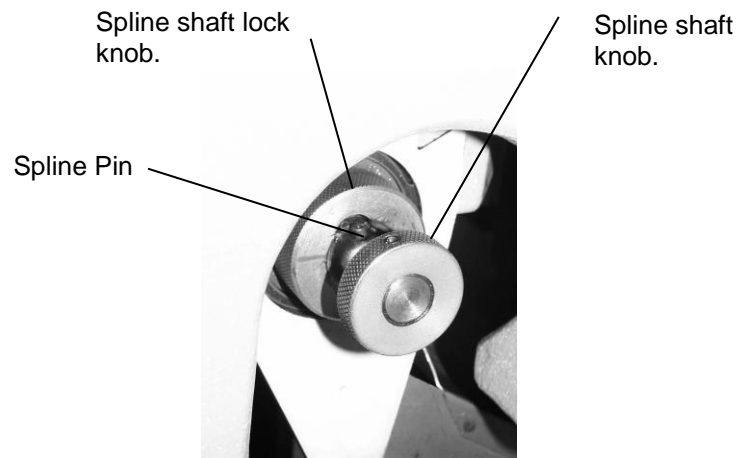

Figure 5

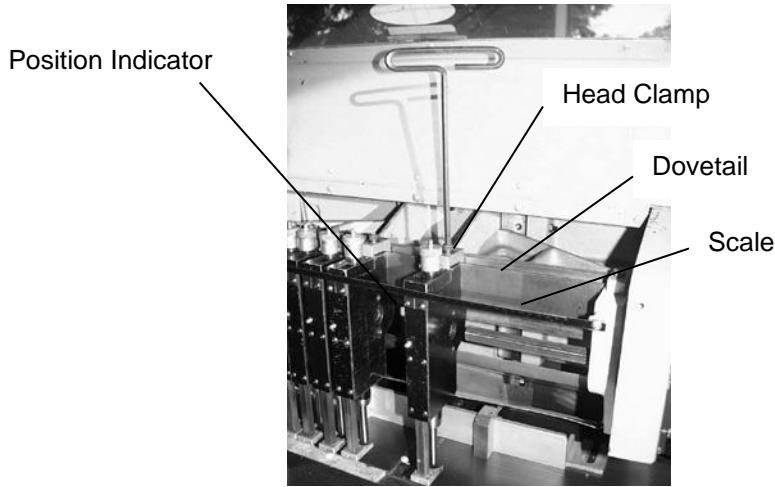

Figure 6

## 6.0 Installation Guide

---

Swing the front cover back until it rests on top of the machine. Loosen the drill head clamp located on the back of the drill head. Place the head on the dovetail of the drill and slightly tighten the clamp screw. Position the head by sliding it along the dovetail and then aligning the drill head indicator with the scale and tightening the clamp screw. (Figure 7)

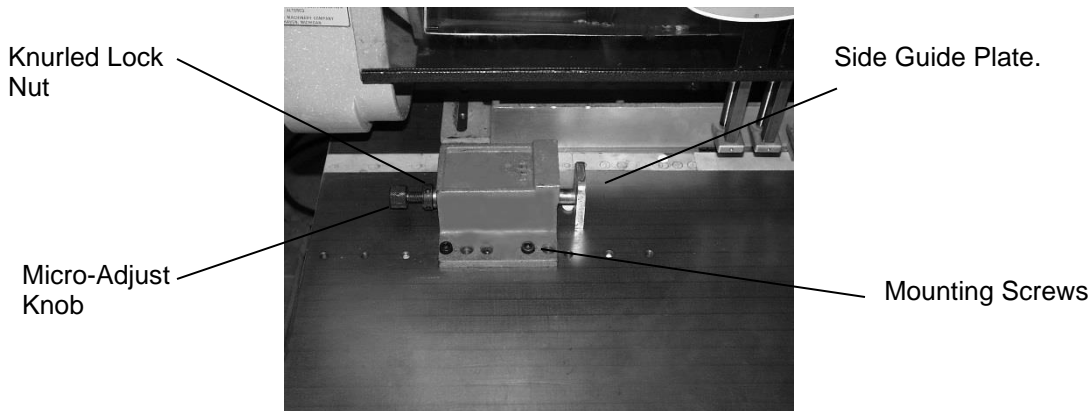

**Figure 7**

Insert the spline shaft through each head (you may have to rotate the spline to align it with the drill head gear) until it seats in the left hand spline bearing. The spline must go in far enough to enable the spline lock ring to secure the spline shaft pin. Insert the spline pin into the lock ring and rotate to lock. (See Figure 5, on page 15) Close and secure plastic cover.

### 6.5.3 Mounting the Side Guide

The side guide is mounted to the table with the two cap screws provided. It can be positioned as necessary along the line of mounting holes in the table. After it is positioned, the guide plate can be adjusted by loosening the knurled lock nut and turning the micro-adjust knob. (Figure 8)



**Figure 8**

### 6.5.4 Installing/Removing the Hollow Drills

#### **CAUTION**

Always handle drills with care to avoid severe lacerations. Even dull drills are sharp enough to cause lacerations.

**TO INSTALL :** Insert the tapered head of the hollow drill into the spindle. Press the drills firmly into place so they do not fall out when the machine is started.

To prevent the drill chips from flying out, be sure that the drift hole covers (black spring bands) are over the drift holes in the spindle. (Figure 9, below)

**TO REMOVE :** Slide the drift hole cover to expose the drift hole in the side of the spindle. Insert the T-handle drill drift into the hole with the flat side down and lift up. (It may be necessary to also twist the handle.) (Figure 10, below)

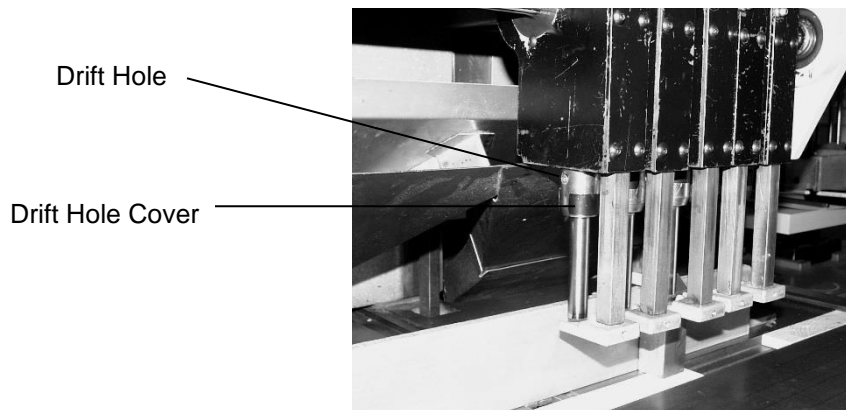

Figure 9

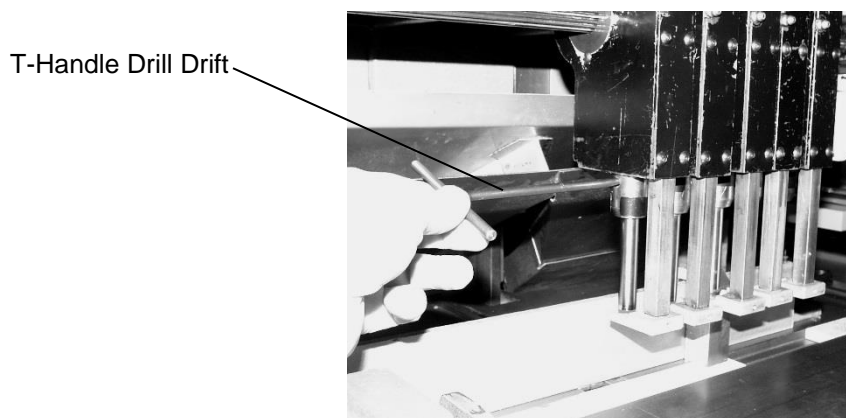

Figure 10

# 7.0 Operation

---

## 7.1 STARTING THE MACHINE

Two motors supply the power to the machine: one is for the hydraulic pump, the other is for driving the drill spindles. Both motors are simultaneously controlled by the start and stop buttons located on the top left of the machine. ( See Controls, pg. 13) Make sure both motors are running in the proper direction before trying to drill paper.

**⚠ CAUTION** Never rest your foot on the foot pedal without intending to bring the drills down!

**⚠ CAUTION** Replace all guards. Do not operate this machine with any guards removed. Severe personal injury could result.

**⚠ CAUTION** Always wear safety glasses when operating this machine.

**Note:** the MS-10B drill is equipped with a safety interlock system which prevents the machine from being started with the chip drawer opened or the front plexiglass cover up. If the chip drawer is opened or the cover raised while the drill is in operation, the machine will shut off and the drills will return the full up position. After the cover or drawer is put back in place the machine can be restarted. This is a safety feature to prevent accidental contact with moving parts and must not be altered.

## 7.2 OPERATING THE DRILL

After the machine is turned on, depressing the foot switch will bring the drill heads to the table. When the drills reach the bottom of the stroke, the drills will automatically return to the full up position. (Note: The vertical stroke of the drills must be set before drilling to provide the proper drill depth. See section...7.3). The foot switch must be released and depressed again before drilling the next set of holes, assuring full control and allowing no repeat stroke. By releasing the foot switch the operator can stop the downward travel of the drills at any time allowing them to return to their normal position, thus preventing costly errors. The MS-10B is capable of up to ten standard drill heads; or two triple drill heads; or two large-hole drill heads. When using standard drill heads or two triple heads, it is recommended that no more than five half-inch drill bits be used at one time. The drill heads are mounted on a dovetail in the machine and are turned by a belt driven spline shaft.

## 7.3 ADJUSTING THE VERTICAL STROKE

The vertical stroke of the machine determines the exact depth the drills will reach at the bottom of their stroke. Whenever installing new drills, the vertical stroke must be adjusted before drilling.

After the drill heads are installed, raise the drill heads to their full up position by turning the handwheel on top of the machine counter-clockwise until it stops. Raise the individual drill heads all the way up by turning the knurled knob on top of the heads counter-clockwise until they stop. After you inserted the drills, place a couple of sheets of the stock you are drilling on the table under the drills. Start the machine. Depress the foot switch, at the bottom of the stroke the drills should not be drilling through.

Adjust the handwheel on the top of the machine clockwise until one drill bit starts to drill through. Next, adjust the remaining drills individually with the adjusting knob on top of each drill head until all of the drills just cut through the sample. It may be necessary to adjust the handwheel slightly when drilling a full lift of stock.

The handwheel must turn with a little friction. Adjust the friction by tightening the setscrew in the upper front of the dovetail. (See Main Assembly – Front View, Ref. no. 45,46 & 47).

## 7.4 POSITIONING THE DRILL HEADS

The drill heads can be adjusted to a minimum center-to-center distance of 1 ¼"(3.2cm) and a maximum of 21"(53cm). To adjust the heads for the desired hole spacing, lift the top cover, locate and loosen the socket head cap screw that clamps the head to the dovetail. Slide the head to the required position using the provided scale, and tighten the clamp screw.

The MS-10B is capable of up to ten standard drill heads; or two triple drill heads; or two large-hole drill heads. When using standard drill heads or two triple heads, it is recommended that no more than five half-inch drill bits be used at one time.

## 7.5 POSITIONING THE BACKGAUGE

The backgauge is positioned by aligning the front edge of the backgauge with the scale that is imbedded in the table. The scale will give you the dimension from the back of the sheet to the centerline of the holes. After the backgauge is positioned, lock it in place with the two knobs provided. To drill less than 1" (25mm) from the edge of the sheet, two filler blocks (provided) must be used. The blocks attach to the face of the backgauge and are locked in place with thumbscrews. The blocks will add 1" to the face of the backgauge, remember this when using the table scale to set the position of the backgauge. Example: To drill ¾" (19mm) from the edge of the sheet, install the filler blocks and set the backgauge to 1-3/4" (4.4cm) on the scale.

## 7.6 EMPTYING THE DRILL CHIP BIN

A large capacity chip bin, located on the front of the machine below the table, is removed by sliding it forward and using the two cut outs in the side of the bin, lifting up, and removing the bin. The bin is safety interlocked. If it is removed while the machine is running, it will shut off. The bin must be in place for the machine to be restarted.

## 7.7 TOOL STORAGE

A convenient tool drawer is provided under the table for storing tools, drill bits, etc.

## 7.8 DRILLING TIPS

**Important!** To prevent the drill from overheating, always avoid drilling too slowly. The drill should be brought down as rapidly as possible allowing the drills to easily cut through the paper.

**Slotted Holes** - Instead of punching slotted holes for five and seven-hole universal binding work, save time and cost by drilling a 1/2 inch diameter hole in place of the slot. The slot is only intended to allow the post or ring to be used in either location, and the large hole permits this.

**Plastic Bindings** - Drilling holes for plastic bindings, instead of punching them, is practical and saves a great deal of time, particularly on long run jobs.

## 7.0 Operation

---

**Keep Drills Sharp** - A dull drill is the major cause of drill breakage and production tie-ups. Usually after three hours of drilling, depending on the type of paper being processed, the drill should be sharpened. A dull drill results in poor quality work.

**Keep Drills Clean** - A dirty and rusty drill will not permit the free upward passage of the drill chips. Pressure built up by a clogged drill will split or break the drill. To keep it free from dirt or rust, clean the drill of all chips after each use and apply light oil to the inside and outside. Drills should be cleaned out immediately after each use. This is particularly true if a coated or varnished stock has been drilled. On these jobs the coating on the chips frequently fuse the chips into one solid mass when the drill cools, causing breakage the next time the drill is used.

**Lubricate Drills** - Lubrication assists in the passage of the chips and helps avoid overheating of the drills. Use readily available stick lubricants for this purpose. Hold the end of the stick against the side of the rotating drill. Be sure to touch the cutting edge with the lubricant also. Wipe off excess oil before drilling. **CARE MUST ALWAYS BE TAKEN WHEN HANDLING DRILLS.**

**Keep Spindle Clean** - Clean out the drill spindle frequently. This will prevent any buildup in the spindle of the drill.

**Set the Drills Correctly** - Do not cut too deeply into the cutting block. The drill should just touch the block and cleanly cut through the bottom sheet. During drilling, do not set the drill deeper into the block but change the position of the block frequently. Drilling deeper into the block dulls the drills quickly. Use a piece of chipboard underneath your stock. This will make handling the stock easier and will ensure that the last sheet is cut cleanly through.

**Check for Drill Wobble** - If the spindle is badly worn or bent through mis-adjustment, have it replaced immediately. A wobbly or loosely held drill will break.

**Check Your Drill Sharpener** - The cutting edge of the sharpening bit should be inspected frequently to make certain that it is sharp and free of nicks. Never let a drill drop onto the sharpening bit. It will chip the sharpening edge. Use gentle pressure when sharpening - let the sharpening bit do the work. Check the sharpness of the drill after sharpening. The cutting edge should be razor sharp.

Just a little time and effort taken with each use of your paper-drilling machine should result in trouble free operation over many years.

**Parts Customers:** The Challenge Machinery Company provides parts with the express understanding that they are to replace parts found missing or no longer serviceable on equipment designed and/or manufactured by Challenge. The Challenge Machinery Company assumes no liability for any modification or alteration to any Challenge products, and The Challenge Machinery Company does not authorize any such modification or alteration to any Challenge products. Any modification or alteration of any Challenge product will void any remaining warranty.

## 7.9 Routine Maintenance

### General

Production losses can be reduced if good maintenance practices are followed. The following suggestions may be helpful:

1. Recognize the fact that the user of hydraulic equipment has more control over maintenance than the manufacturer.
2. Technicians should be familiar with use, care, and limitations of the equipment. Technicians and/or maintenance personnel **SHOULD READ THIS MANUAL COMPLETELY**.
3. Use properly trained maintenance personnel.
4. Establish a program of systematic preventative care for your equipment or put this machine on an existing preventative maintenance program.
5. Analyze and isolate trouble before having any part of the equipment dismantled.
6. Be aware of how your machine should sound and perform. If the machine is not operating properly or if it doesn't "sound right", stop running your job immediately and try to identify the problem.
7. Call the dealer for any problems that cannot be handled by your own personnel.



Always handle drills with care to avoid severe lacerations, even dull drills are sharp enough to cause lacerations.

### Daily

1. **Keep drills sharp!** Sharpen drills often and reset the drill depth if needed.
2. Lubricate the hollow drills frequently with the Drillease provided.
3. For better hollow drill life, remove the drills when not in use and soak in light oil. Wipe off excess oil before drilling.
4. Oil the vertical gibs through the two oil ports in the top cover of the machine. Wipe excess oil from the bottom of the gibs.
5. Wipe off excess grease from the spline shaft and drill heads.

### Weekly

1. Spray the chip chute with silicone spray to prevent the drill chips from sticking and piling up.
2. Grease the drill heads with the grease gun provided in the tool kit.

# 8.0 Accessories

## 8.1 Genuine Challenge Hollow Drills

Available in 13 standard sizes.

### 2"/51 mm

Hole Diameter	Drilling Capacity	Part Number
1/8"/3.2 mm	5/8"/16 mm	CD-2-3
5/32"/4 mm	1-1/8"/28 mm	CD-52
3/16"/4.8 mm	1-5/8"/41 mm	CD-3
7/32"/5.6 mm	1-5/8"/41 mm	CD-72
1/4"/6.3 mm	2"/51 mm	CD-4
17/64"/6.7 mm	2"/51 mm	CD-174
9/32"/7.1 mm	2"/51 mm	CD-92
5/16"/7.9 mm	2"/51 mm	CD-5
11/32"/8.7 mm	2"/51 mm	CD-112
3/8"/9.5 mm	2"/51 mm	CD-6
13/32"/10.3 mm	2"/51 mm	CD-132
7/16"/11.1 mm	2"/51 mm	CD-7
1/2"/12.7 mm	2"/51 mm	CD-8

### 2-1/2/63.5 mm

These drill bits will only fit the EH-3A, EH-3C, EH-3D, MS-5, MS10-A & MS-10B.

Drill Bit Diameter	Part Number
1/4"/6.3 mm	CD-4-2-1/2
5/16"/7.9 mm	CD-5-2-1/2
3/8"/9.5 mm	CD-6-2-1/2
1/2"/12.7 mm	CD-8-2-1/2

**NOTE: ALL DRILLS CAN BE ORDERED TEFLON COATED. JUST ADD A "T" BEFORE THE CD PART NUMBER OF THE DRILL.**

## 8.2 Drill Ease

### Cat. No. 4688

This lubricating stick provides a dry stainless lubricant, which has many uses throughout the printing plant. It is specially recommended for use on hollow drills for easier drilling, particularly when drilling clay-coated stock. It eliminates binding and excessive heating of the drill. Will not discolor the stock.

CARE MUST ALWAYS BE TAKEN WHEN USING STICK AND HANDLING DRILLS.

## 8.3 Challenge Drilling Blocks

### Cat. No. A-6626-24

These Challenge 1x6" / (3 x15 cm) wood drilling blocks are for round hole drilling operations. Sold in packages of 24.

## 8.4 Hollow Drill Hand Sharpener

Cat. No. A-4950-2

*For fast, easy drill sharpening*

### **⚠ CAUTION**

Drills are sharp even after use. Be careful to keep edge away from your body. To prevent personal injury and/or damage to the drill, ALWAYS keep drills in protected area.

Here's a unit that really makes drill sharpening easy. All you do is place the hollow drill in the tapered end of the drill holder, insert the unit on the cylinder, then turn two or three times...and you have a perfectly sharpened drill.

This Challenge Hollow Drill Sharpener can pay for itself many times over through longer drill life, easier, faster drilling, and less sharpening time. All sizes of drills from 1/8 to 1/2 inch in diameter can be sharpened.

The drill sharpener automatically puts just the right amount of bevel on the hollow drill for the best drilling results. It's self-centering, too, so that the center of the sharpening bit exactly meets the center of the hollow drill. The drill sharpener also has a replaceable sharpening bit.

**Extra Cutting Bit**

**Part No. 4952**

### CHIP REMOVER

1. CAREFULLY place a hollow drill in the holder section as shown, and insert the holder (with drill) into the chip remover end as shown.
2. Firmly tap the entire assembly on a solid surface to remove the chips from the hollow drill.

**Note: The chip remover can only be used with hollow drill diameters of 3/16" and larger.**

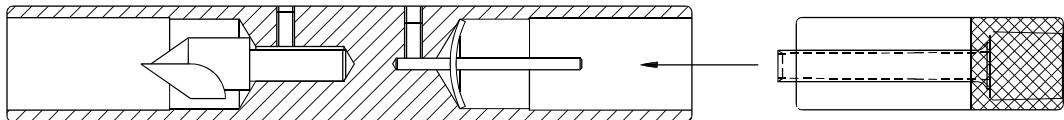

### DRILL SHARPENER

1. CAREFULLY place a hollow drill in the holder section as shown, and insert the holder (with drill) into the sharpener end as shown. Be very careful to bring the drill and cutting tool together without bumping. **The cutting tool is made of GLASS HARD material and may be chipped.**
2. USE CLOCKWISE ROTATION while maintaining an even pressure, until the hollow drill is sharpened (usually two or three turns). The cutting tool seldom requires replacing, but when it does become necessary, the bit can be ordered through your Challenge Dealer (p/n 4952)

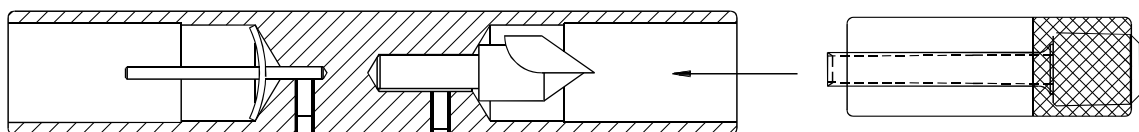

## 8.5 Handy - Sharp - Hollow Drill Sharpener

Catalog No. 57100

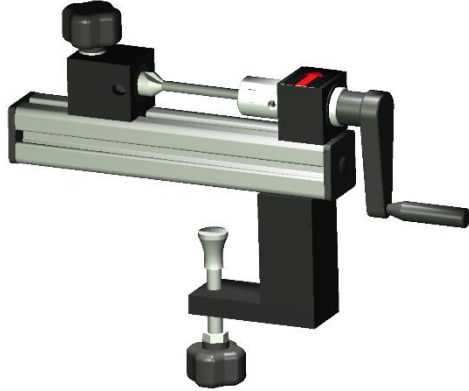

**Features:**

- Spring- loaded pressure prevents flaring the end of the hollow drill bit.
- Light and portable, easy to use.
- Clamps onto a bench or table.
- Repairs "far-gone bits"

The Handy - Sharp mounts on the edge of a table or bench. A dull hollow drill bit is placed in the holder, and the cutting bit is pushed against the end of the hollow drill bit until its spring bottoms out. The spring prevents excessive force from being applied while sharpening. Turning the handle while applying a hone produces a fine edge.

Maintaining a sharp hollow drill bit has two distinct benefits. First sharp bits increase the life of your drilling machine by reducing the force required to drill, thereby minimizing wear and tear on the machine. Second, dull hollow drill bits are more likely to break or flare, costing money and creating downtime.

**General:**

Hollow drill sizes	1/8"to 1/2" diameter
Width	1-1/2"
Depth	13-7/16"
Height	4-5/32"
Net weight (approx.)	8 lbs.
Shipping weight (approx.)	9 lbs.

**Packing List:**

57100	Handy-Sharp (basic machine)
57108	Hone
4687	Drill Drift
4688	Drill-Ease Lube

**Options:**

A-4950-1	Hollow Drill Chip Remover
57114	Adapter- Lawson / Nygren-Dahly

## 8.6 Two Hand Push Button Control

**Catalog No. A-4851-51**

This 2-hand control safety kit can be installed on the MS-10B in place of the standard foot pedal control. All of the necessary hardware and instructions are included in the kit. The 2-hand control offers anti-tie down and anti-repeat features, which means both buttons must be released between each cycle, and both buttons must be pressed within .5 seconds of each other.

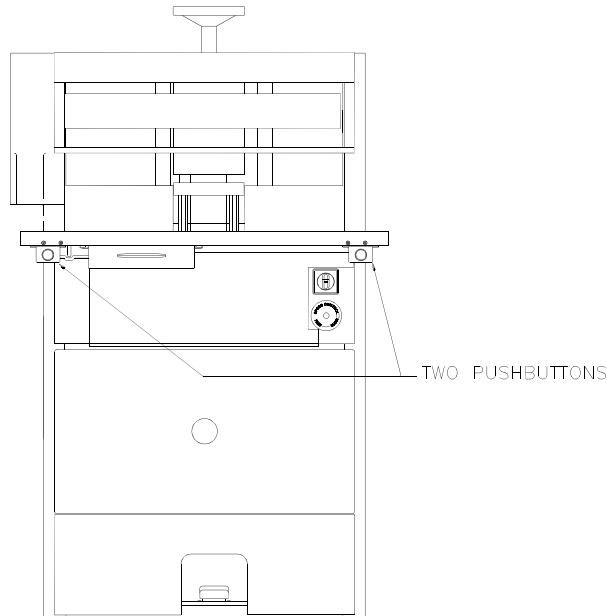

## 8.7 Extension Side Tables

22 x 48"/56 x 122cm Provides additional working area. Can order left, right or both.

Right Side **Catalog No. A-6620**

Left Side **Catalog No. A-6620-1**

## 8.8 Wheeled Dolly

Makes the MS-10B portable. Steel base with heavy-duty casters.

**Catalog No. A-6686**

## 8.9 Cornermatic Round Cornering Attachment

**Catalog No. AA-4980-3** 1" capacity. Includes 7/16" radius knife & holder.

### Cornermatic Knives

1/8"/3.2 mm	#4981-2	7/16"/11 mm	#4981-7
1/4"/6.3 mm	#4981-4	1/2"/13 mm	#4981-8
3/8"/9.5 mm	#4981-6		
Straight Diagonal	#4982		

## 8.10 Fiber Cutting Blocks

**Catalog No. A-12607**

These are recommended for use with the Cornermatic Round Cornering Attachment.

## 8.11 Plastic Drilling Blocks

**Catalog No. 6669**

**Used for large hole drilling only.** 2-1/4" X 6" ( 57/ 152cm)

## 8.12 Automatic Trip Side Guide

**Catalog No. A-6565-3**

Fits left side and includes six adjustable stops. Can be used for step drilling on multiple hole patterns.

## 8.13 Extra Side Guide Stops

**Catalog No. S-1611-R** For automatic trip side guide.

## 8.14 Fixed Side Guide

**Catalog No. A-6565**

For single lift drilling; second side guide for drilling two lifts in one stroke; or for drilling a lift on the right and left side guides in two strokes.

## 8.15 Fixed Side Guide Gages

**Fixed Gages** - Saves time on multiple patterns. Fit in the auto trip side guide in place of adjustable stops. Spacing is center-to-center distance of holes.

24 stops 1/4"/6.3 mm spacing **#6653-4**

16 stops 3/8"/9.5 mm spacing **#6653-3**

12 stops 1/2"/13 mm spacing **#6653-2**

Limited to those sizes presently in stock.

## 8.16 Chip Chute Extension

Empties chips out the rear of machine instead of into drill base bin.

**Catalog No. #A-6676**

## 8.17 Drill Head Grease

1 pint. For lubrication of MS-10B Drill Heads.

**Catalog No. 6614**

## 8.18 Rykon 100 Hydraulic Oil

(Capacity 1-1/2 quarts) Available in 5 gallon container only. **Catalog No. S-1991-4**

## 8.19 Large Hole Hollow Drill bits

2"/51 mm drilling capacity. For use with large hole drilling head only. Sizes other than those listed, available on special order.

<b>Size</b>	<b>Part #</b>	<b>Size</b>	<b>Part #</b>
9/16"/14 mm	<b>KDG-9</b>	1-1/8"/29 mm	<b>KDGB-2</b>
5/8"/16 mm	<b>KDG-10</b>	1-1/4"/32 mm	<b>KDGB-4</b>
3/4"/19 mm	<b>KDG-12</b>	1-3/8"/35 mm	<b>KDGB-6</b>
1"/25 mm	<b>KDG-16</b>	1-1/2"/38 mm	<b>KDGB-8</b>
		1-5/8"/41 mm	<b>KDGB-10</b>

